

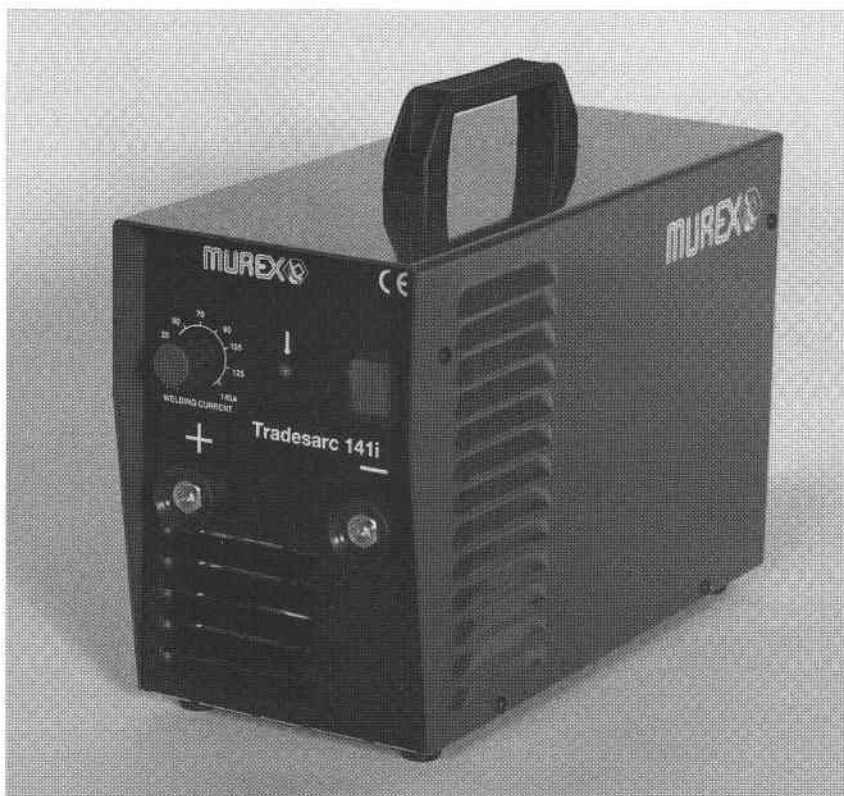

Operating Manual

Tradesarc 141i



**Please ensure that this
Instruction Manual and Parts List
is made available to the user of
the equipment**



DECLARATION OF CONFORMITY

Murex Welding Products Ltd.

Declare hereby that:

Murex Tradesarc 141i Power Source

Part No: 1415504

- is manufactured in accordance with the Council Directive 73/23/EEC (1973-02-19) and 89/336/EEC (1989-05-03) amended by Council Directive 93/68/EEC relating to electrical equipment designed for use within certain voltage limits.
- conforms with the protection requirements of Council Directive 89/336/EEC, amended by Council Directives 91/263/EEC, 92/31/EEC and 93/68/EEC relating to electromagnetic compatibility.
- is manufactured in accordance with EN60974-1 Safety Requirements for Arc Welding Equipment.
- is manufactured in accordance with EN50199 Electromagnetic Compatibility for Arc Welding Equipment.

On behalf of Esab Group (UK) Ltd
Hertford Road
Waltham Cross
Herts. EN8 7RP
England

A handwritten signature in black ink, appearing to read "P.G. Dodd".

P.G. Dodd
Managing Director
Esab Group (UK) Ltd
1st January 1999



Contents

	Page
• Safety	5
• Introduction	6
• Specification	6
• Installation	6
• Controls & Facilities	8
• Operation	9
• Fault finding	11
• Maintenance	12
• Warranty	12
• Optional Extras	12
• Spare Parts Information	14



WARNING



This welding equipment has been designed, manufactured and tested to the highest standards to ensure long and trouble free life. However, regular maintenance is an essential part of keeping the machine operating in a reliable and safe manner and your attention is drawn to any maintenance instructions that are contained in this manual.

In general, all welding equipment should be thoroughly inspected, tested and serviced at least annually. More frequent checking will be required when the equipment is heavily used.

Wear and tear, particularly in electro-mechanical and moving components, are gradual processes. Caught in time, repair costs are small and the benefits in performance reliability and safety are significant. Left alone, they can put the equipment, and you, at risk.

Have this equipment regularly inspected and maintained by an approved service centre.



WARNING



ARC WELDING AND CUTTING CAN BE INJURIOUS TO YOURSELF AND OTHERS. TAKE PRECAUTIONS WHEN WELDING. ASK FOR YOUR EMPLOYER'S SAFETY PRACTICES WHICH SHOULD BE BASED ON MANUFACTURERS' HAZARD DATA.

ELECTRIC SHOCK - Can Kill

- Install and earth the welding unit in accordance with applicable standards.
- Do not touch live electrical parts or electrodes with bare skin, wet gloves, or wet clothing.
- Insulate yourself from earth and work.
- Ensure your working position is secure.

FUMES AND GASES - Can be Dangerous to Health

- Keep your head out of the fumes.
- Use ventilation, extraction at the arc, or both, to keep fumes and gases from your breathing zone and the general area.

ARC RAYS - Can Injure Eyes and Burn Skin

- Protect your eyes and body. Use the correct welding screen and filter lens and wear protective clothing.
- Protect bystanders with suitable screens or curtains.

NOISE - Excessive noise can damage hearing

- Protect your ears. Use ear defenders or other hearing protection.
- Warn bystanders of the risks.

**READ AND UNDERSTAND THE INSTRUCTION MANUAL
BEFORE INSTALLING OR OPERATING AND SEE 18 PUBLICATION 237
'The arc welder at work' AVAILABLE FROM THE MANUFACTURER.**

PROTECT YOURSELF AND OTHERS

SAFETY

In any arc welding or gouging operation, it is the responsibility of the user to observe certain safety rules to ensure his personal safety and to protect those working near him.

Read all safety articles relevant to arc welding published by the 18. Pay particular attention to any CAUTION or WARNING Notes included in this manual. CAUTION indicates possible equipment damage. WARNING indicates possible hazard to life.

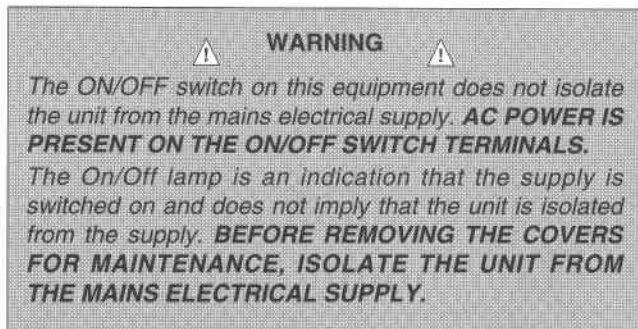

1. Electrical

- ⚠ Treat electricity with respect. Even the open circuit voltage of this equipment can be dangerous. Adjustments to the torch or replacement of torch parts should be undertaken with the mains supply isolated from the unit.
If damaged torch cables or torch components are found, the unit must be disconnected from the mains and defective parts must be replaced using only Murex spare parts.
- ⚠ Do not work on live circuits or cables. Disconnect the main power supply before checking the machine or performing any maintenance operation.
- ⚠ Be sure the case of the welding machine is properly connected to a good electrical earth.
- ⚠ Have the wiring for the welding machine installed by a qualified electrician. All connections must be made according to specifications in force and to general safety standards.
- ⚠ Do not stand in water or on damp floors while using an arc welder or cutter. Do not use in the rain.
- ⚠ Do not operate with worn or poorly connected cables. Inspect all cables frequently for insulation failure, exposed wires and loose connections.
- ⚠ Do not overload cables or continue to operate with overheating cables. Cables which are too small for the current carried will overheat, causing rapid deterioration of the insulation.
- ⚠ Pay attention that live parts of the torch do not touch any metal which is connected to the earth cable. Fix an insulated hook to hang the torch on when it is not in use.

1. Ventilation

- ⚠ Do not weld or cut on containers which have held combustible or flammable materials, or materials which give off flammable or toxic vapours when heated, without proper cleaning.
- ⚠ Locate the welding/cutting operation far enough from any vapour-type degreaser using trichlorethylene or other chlorinated hydrocarbons as solvents. The ultraviolet light from the arc can decompose these vapours into toxic gases at a considerable distance from the arc, even though the concentration of the gases is low enough to be undetectable by smell.
- ⚠ Be sure to provide adequate ventilation for removal and dilution of fume and gases. Fume exhaust facilities near the arc, or a ventilated helmet should be used when cutting in confined spaces or on toxic material.

2. Glare

- ⚠ Never look at the arc without wearing eye protection. Always use the proper protective clothing, filter glasses, and gloves. Be careful to avoid exposed skin areas. Do not use cracked or defective helmets or shields.
- ⚠ Never strike an arc when there is someone near who is not protected from the strong light of the arc.
- ⚠ Warn bystanders who are not aware of the dangers of ultraviolet light.

3. General

- ⚠ Take care when lifting the unit.
- ⚠ Ensure that cylinders are secured by chains.
- ⚠ Locate the unit so that there is adequate air flow to the ventilation louvres.
- ⚠ Always dress correctly to protect against glare, radiation and spatter.

4. Fire

- ⚠ Ensure that the correct type of fire extinguisher is available in the welding area.
- ⚠ Do not weld near flammable materials or liquids, in or near explosive atmospheres, or on pipes carrying explosive gases.

5. Vehicle Electrics

- ⚠ When working on motor vehicles, remove the battery and any circuitry which may be damaged by the arc.
- ⚠ Whilst welding be aware of the possibility of 'hidden wires' behind panels or bulkheads.

INTRODUCTION

The Murex Tradesarc 141i is a small, portable, inverter based power source for MMA or TIG welding using the scratch start method. The unit provides up to 140A welding current and operates from a 230V single phase electricity supply. The 141i is housed in an all metal enclosure, a small fan at the rear providing cooling for the internal semiconductor components. A thermal sensor built into the unit prevents excessive temperatures should the unit be overdutied and output is disabled and a front panel warning light illuminated under such circumstances.

In combination with an optional TG123V TIG torch and Argon gas supply the 141i can be used for TIG welding of stainless components and the like.

Specification

Input

Mains Supply	230V 1 phase 50/60Hz
Power (max)	4.3 KW
KVA (max)	5.3 KVA
Fusing	16A* slow

Output

Current Range	5 - 140A dc
Rating TIG	140A/16V at 60% duty 110A/14V at 100% duty
MMA	120A/25V at 60% duty 95A/24V at 100% duty
OCV	70V dc

Dimensions

Length	337mm
Width	146mm
Height	210mm
Weight	7.5Kg (net)

Standards

EN60974-1 & EN50199

* A 13A slow fuse is adequate for most applications

INSTALLATION

Radio Interference

Murex welding power sources have been designed to high standards of electromagnetic compatibility. However, arc welding, by its very nature, generates radio-frequency energy and may cause interference. By installing and using the equipment correctly, in accordance with these instructions, the problems of interference may be minimised.

This equipment satisfies the requirements of the EU Directive 89/336/EC on EMC and complies with the limits in EN 50 199, 'EMC product standard for arc welding equipment'. These limits are designed to provide reasonable protection against interference in heavy industrial areas.

If this equipment is used in domestic areas, eg. for repair or maintenance, particular care should be taken. The time of day should be chosen and the duration of welding limited, to minimise any potential problems.

If this equipment caused interference the guidance given below should be considered. If a solution cannot be found please contact your distributor or the manufacturer.

Before installing this welding equipment an assessment should be made of potential EMC problems that may occur. It is good practice not to install welding equipment next to computers or safety critical control circuits, eg electronic machine guards, unless they have been suitably protected.

This equipment should be connected to the primary supply using the cable provided. However, for permanent installation, if interference problems occur, shielded cable or conduit should be considered. The primary cabling and welding cables should be kept separate to other mains wiring and control, signalling or communications (eg telephone) cables. If interference occurs then greater separation or re-routing should be considered. Welding cables should be kept as short as practically possible.

Interference may also be reduced by separating the welding equipment from the other equipment affected. A partition, brick wall or particularly, a metal screen will also reduce interference. Earthing and equi-potential bonding should also be considered but guidance should be sought from a competent person, the distributor or manufacturer.

To ensure continued compliance to the EMC Directive this equipment should be routinely maintained according to the manufacturers instructions and using only approved spare parts. In particular, the spark gaps of HF units should be adjusted and maintained according to the manufacturers recommendations.

All access and service door and covers should be closed and properly fastened when the equipment is being used. This equipment should not be modified in any way except for those changes and adjustments approved by the manufacturer.

Connection to the Mains

The Tradesarc 141i must be used on 230V single phase electricity supply. A standard 13A domestic mains fuse is adequate for most MMA or TIG applications. For high duty applications using 3.2mm electrodes at 140A for example, a 16A slow fuse must be used.

IMPORTANT!

The green/yellow earth lead must be connected to a good earth ground.

Mains extension leads

Care must be taken when supplying the unit via long mains extension cables. On 230V supplies the recommended cross section of such cables is 2.5mm².

Siting the unit

Position the unit to give good all-round ventilation. Do not block the air inlet on the rear panel or the front or side panel louvers. Preferably choose an off-floor location away from dust, dirt or damp.

Welding Cables

The recommended cross-sectional area of each welding cable should be not less than 15mm². If using welding cables over 5m long, 25mm² cable should be used to prevent voltage losses.

CONTROLS & FACILITIES

THERMAL OVERLOAD INDICATOR

Indicates 'overload' condition. If the lamp lights, leave the unit switched on with the fan running and allow to cool. Reset is automatic after the unit cools.

POWER ON/OFF SWITCH

WELDING CURRENT CONTROL
Output current can be set in the range 5 to 140A

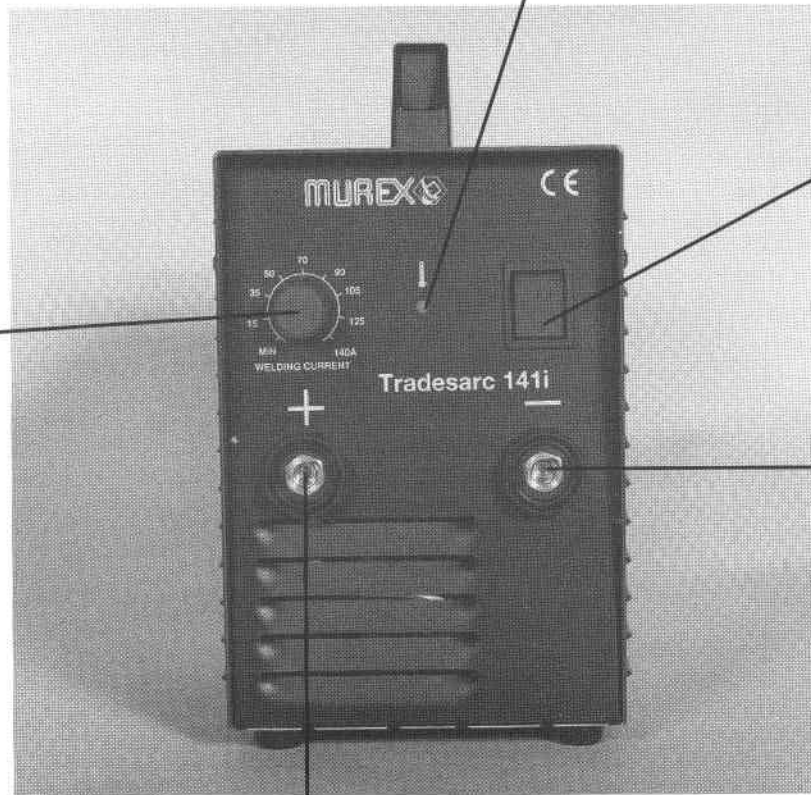

Connection for work return (electrode +ve mode)

Connection for MMA electrode holder (electrode +ve mode)

OPERATION MMA Welding

WARNING!

The Power/Input Voltage Selector switch on this equipment does not isolate the unit from the mains electrical supply. AC POWER IS PRESENT ON THE SWITCH TERMINALS.

BEFORE REMOVING THE COVER FOR MAINTENANCE, ISOLATE THE UNIT FROM THE MAINS SUPPLY.

Whilst welding try to adopt a relaxed attitude

1. Always commence with a last minute check for safety and protection.
2. Check that the electrode holder and work return lead connections are secure.
3. Fit the appropriate size of electrode
4. Using the current control, set the welding current.
5. Hold the electrode away from the work, trailing the welding lead over the shoulder to reduce the weight on the hand doing the welding.
6. Keeping the electrode clear of any exposed metal surface, switch on the unit.
7. Position the electrode close to the point where welding is to commence, without actually touching the work.
8. Cover the eyes with a headscreen or

handshield and warn bystanders.

9. (a) Scrape the electrode on the work surface at the start point (as though striking a match). The arc should strike.

(b) Carry on scraping the electrode across the surface of the workpiece until the arc is almost continuous, then feed the electrode into the hot pool of molten metal keeping the electrode at approximately 65-80° to the workpiece.

If the electrodes 'freezes', i.e. sticks to the workpiece, gently twist the electrode and pull it free. If this is not possible, switch off the supply, release the electrode from the holder, and cut the electrode free with a chisel. Freezing will occur if heavy contact is made with the workpiece at too low a current setting.

(c) Once the arc is successfully struck adjust the arc length to about the size of the electrode diameter.

(d) The correct length of arc, (size of weld 'bead') is acquired by feeding the electrode backwards and downwards into the weld.

This combination of backward and downwards movement requires a little skill which will be acquired after a few practice welds.

10. Allow the weld to cool.

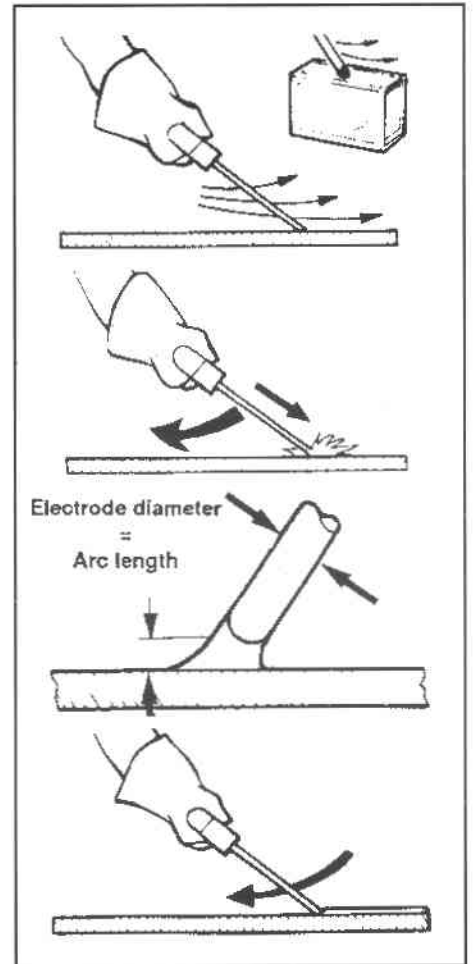

MANUAL METAL ARC ELECTRODES

Electrode Type	dia. (mm)	Materials
Zodian Universal	2.5 to 3.2	Mild steel, general purpose work
Satinex	2.5 to 3.2	Mild steel, medium tensile steels
Fortrex 7018	2.5 to 3.2	Carbon and low alloy, mild steel and medium tensile steels
Ferex 7018LT	2.5 to 3.2	Medium tensile steels and mild steels
Nicrex E316L-17	2.0 to 4.0	Stainless steels
Armoid 1	2.5 to 3.2	High tensile stainless steels. Dissimilar

This chart is given as a general guide to the MUREX electrodes for the Tradesarc 141i. For more detailed information, contact your local MUREX distributor

TIG WELDING

Preparation

Read again the Safety Notes at the front of this manual

1. Connect the work return lead to the positive socket.
2. Connect the torch power lead to the negative 'work' socket.
3. Fit the regulator and gas flow meter to the gas cylinder and, using a cylinder key, turn on the gas and adjust the gas flow for a 6 to 7.5 litres/minute (12-15cu.ft/hr.) indication on the flow meter.
4. Connect the torch gas lead to the regulator, and turn on the gas supply.
5. Fit an appropriate sized 2% thoriated electrode to the torch - see 'Electrode Guide' and set the electrode 'stickout' to between 4-7mm. Check the electrode is correctly ground.,
6. Clean the material to be welded with a wire brush or grinder.

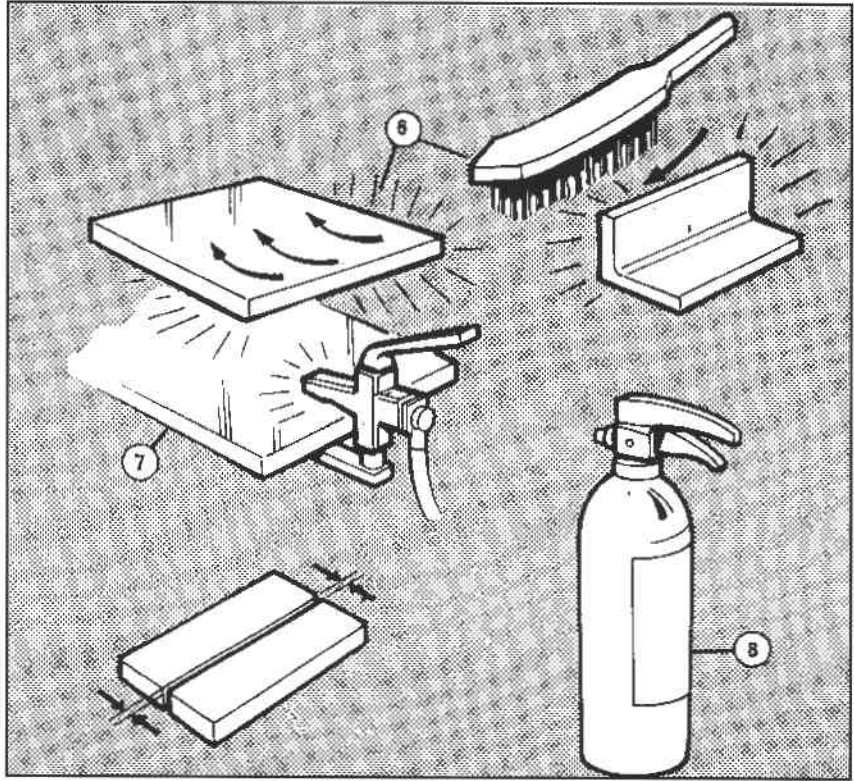

7. Clamp the work return lead to the work piece ensuring good electrical contact.
8. Clear the welding area and check that a fire extinguisher is available.

Technique

1. Set the output current control as required. It is difficult to scratch start at currents less than 15A. Once the arc is struck the current can be lowered as required.
2. Switch on the unit
3. Switch on the gas flow to 'purge' the gas lines, adjust the gas flow for a 6-7.5 ltrs/per min. (12-15 cu.ft/hr) indication on the flow meter.
4. Adopt a good welding position and hold the torch and filler rod at the correct angles. Holding the rod and torch at these angles is necessary to ensure satisfactory results.
5. Position the torch over the welding area (about 25mm above) warn bystanders to shield their eyes and lower your headscreen.

6. Strike the arc by scratching the tungsten electrode on the workpiece in the same manner as that described for manual metal arc. Improved striking will be obtained by striking the arc on a carbon block and then transferring the arc to the workpiece.
7. Wait for a pool to form and, when the edges of the molten material flow together, move the torch from right to left (right handed welder) adding filler wire as necessary. (Keep the filler rod tip inside the gas shroud).

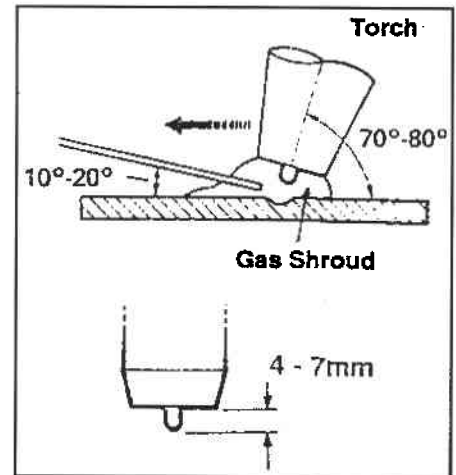

Torch and filler rod angles and Electrode stick-out

TIG ELECTRODES

In order to obtain the optimum arc striking performance with the Tradesarc 141i it is recommended that 2% Thoriated tungstens are exclusively used (red tip).

Maximum Electrode Ratings d.c.

Electrode Dia.	Length	Max. Current
1.2mm (3/6in.)	150mm	70A
1.6mm (1/16in.)	150mm	150A

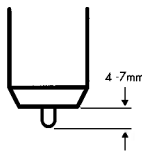

Shielding Gas

To prevent oxidation, always purge the argon hose before welding and maintain the argon flow until the tungsten has cooled sufficiently after welding has ceased.

WELDING AND GENERAL FAULTS

	Fault	Remedies
Surface porosity	a) Insufficient shielding gas (TIG). b) Bore of nozzle too small (TIG). c) Surplus degreasing agent (MMA & TIG) d) Arc too long (MMA and TIG). e) Incorrect torch or rod angle (TIG). f) Poor quality materials (MMA and TIG)	a) Check shielding gas flow. b) Fit larger ceramic nozzle. c) Remove degreasing agent and dry. d) Shorten the arc. e) Correct the angles -see TIG welding f) Use better quality materials.
Undercut (MMA and TIG)	a) Incorrect welding technique. b) Current too high. c) Incorrect welding speed. d) Wrong electrode (MMA).	a) Correct rod handling. b) Reduce current setting. c) Increase hand travel speed. d) Change to correct size (type).
Lack of penetration (MMA and TIG)	a) Insufficient current. b) Welding too fast.	a) Increase current setting. b) Decrease hand travel speed.
Cracking and Inclusions	These faults are difficult to detect without the use of specialised equipment. If cracking shows, seek the advice of a welding engineer.	
No welding output	a) Thermostat tripped b) Mains input fuses blown.	a) Cease welding and allow the fan to continue to run thereby cooling the unit. Decrease welding duty cycle (welding on to off time). b) Replace with the same value fuse.
No Arc Strike In TIG	a) Contaminated Tungsten b) Poor welding circuit c) Current set below 15A	a) Regrind/Replace Tungsten b) Check cables c) Increase current setting

WARNING

Always wear goggles and a mask when grinding electrodes.

flat
Straight Ground
Stable arc

Radial Ground
point
Arc wander

Do not grind the electrode radially or 'arc wander' may occur

MAINTENANCE

WARNING

Maintenance involving the removal of the outer cover must only be undertaken by qualified or suitably trained personnel.

Switch off and disconnect the unit from the mains supply before under-taking any maintenance tasks.

Daily (Operator task)

1. Check all welding and electrical cables for signs of cracking or general deterioration.
2. Check that all electrical (and gas) connections are in good physical condition.
3. Check the torch or electrode holder for damage. Replace any suspect part(s).

ALWAYS CHECK THE WELDING AREA DAILY FOR POSSIBLE SAFETY HAZARDS. IF IN DOUBT CONSULT YOUR SAFETY OFFICER.

Monthly (Maintenance Department Task)

1. Switch off the unit and disconnect from the mains electrical supply.
2. Remove the cover (retain the fixing screws)
3. Using a soft brush, remove any dust or dirt from the interior of the unit. If compressed air is used to clean the unit the pressure must not exceed 30lbs/in², and the air must be dry.

SUITABLE EYE AND MOUTH PROTECTION SHOULD BE WORN.

4. Replace the cover.
5. Reconnect the unit to the mains supply.

WARRANTY

Murex offers a full, normally on-site, guarantee on all its welding and cutting equipment. The Tradestig 141i power source is guaranteed for a period of 12 months from date of purchase. If during this period the product proves defective due to incorrect design, materials or workmanship, Murex or its authorised Service Centre will, free of charge, repair or at the discretion of the company replace the product or its defective parts.

Please note that the guarantee on associated items, torches, electrode holders etc is 3 months.

This guarantee excludes:

1. Normal wear and tear of consumable parts, contact tips, electrodes, nozzles, liners, guides, feed rolls, feed roll gears, motor brushes, relay/contactors etc
2. Damage resulting from misuse, accident, lack of maintenance, incorrect installation or misapplication.
3. Repairs carried out by non-authorised personnel or the use of non Murex replacement parts.
4. Loss of use of the product and other incidental or consequential costs incurred by the purchaser.

OPTIONS

- | | |
|---------|--|
| 1407721 | MMA Accessory Kit (work return and electrode holder) |
| 1412652 | TIG Scratch Start kit |

Circuit Diagram Tradesarc 141i

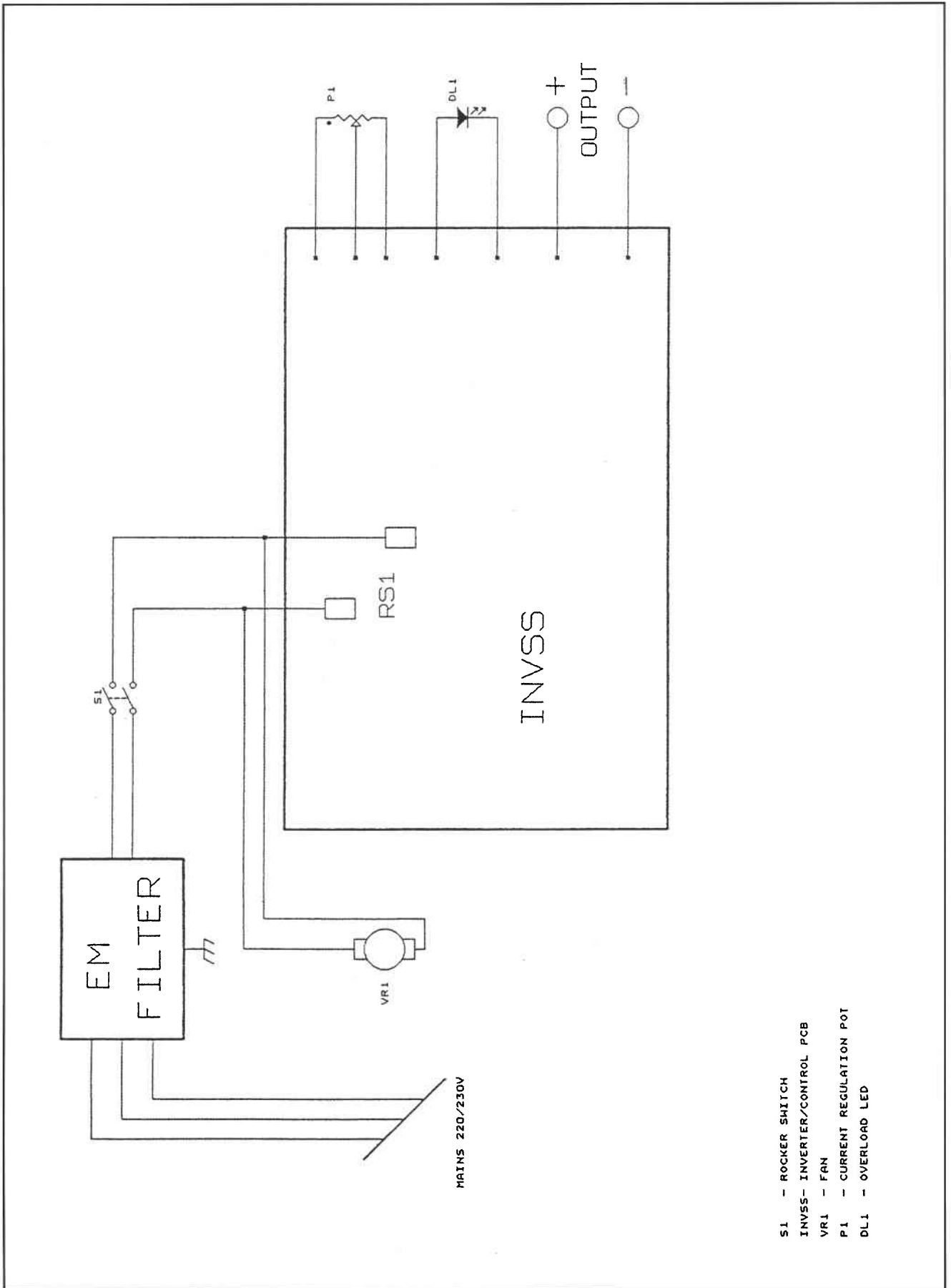

- S1 - ROCKER SWITCH
- INVSS- INVERTER/CONTROL PCB
- VR1 - FAN
- P1 - CURRENT REGULATION POT
- DL1 - OVERLOAD LED

PARTS LIST

	Pt. No.	Description	Cct. Ref.
1	1415480	Fan	VR1
2	1415481	EMC Filter	-
3	1415485	Power Switch	S1
4	1415482	Yellow LED	DL1
5	1415496	Potentiometer 100k Ω	P1
-	1415497	Knob for item 5	-
6	1404314	Dinse Socket	-
7	1415574	Inverter pcb ass'y	

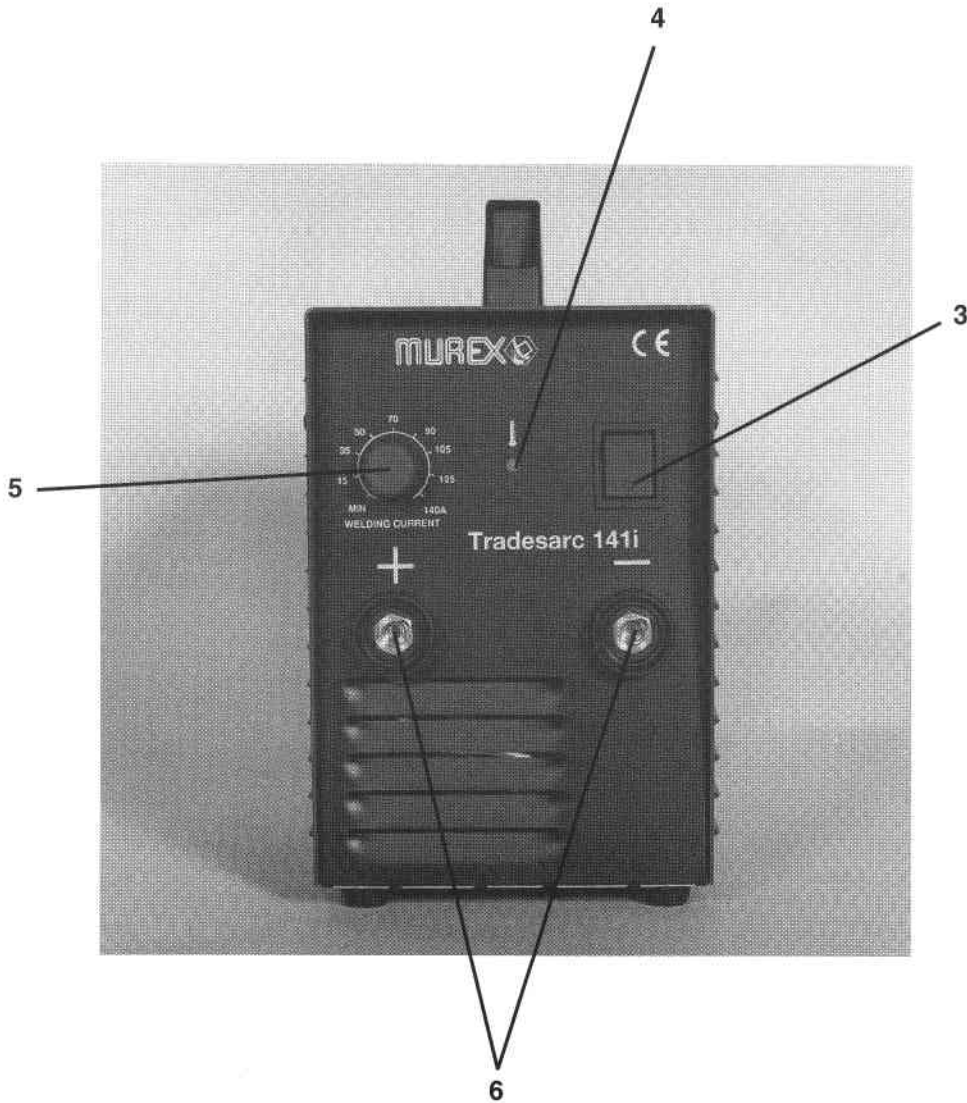

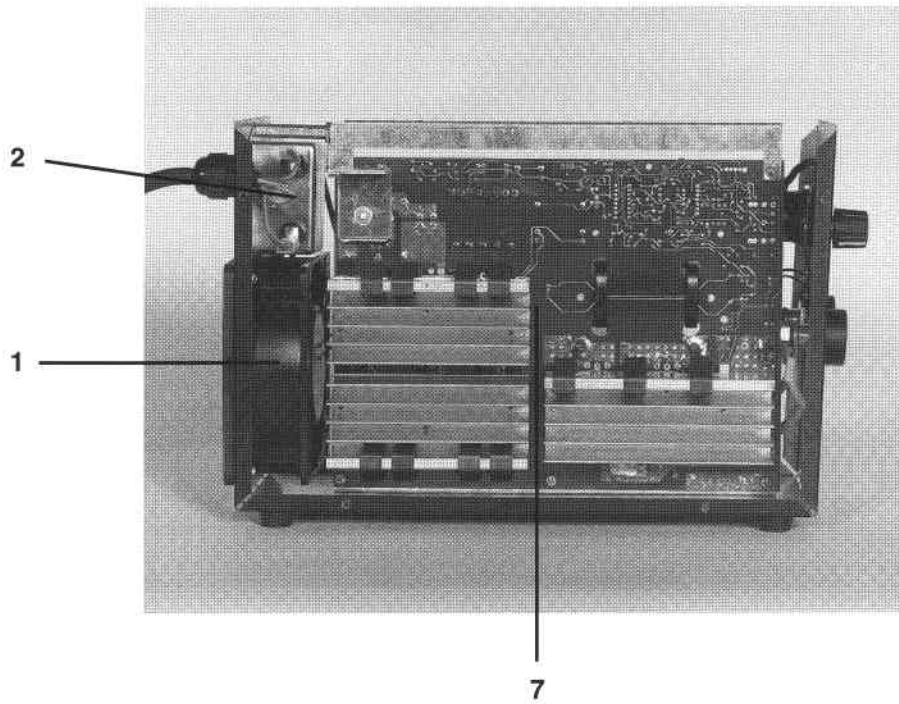



Murex Welding Products Limited
Hertford Road, Waltham Cross,
Herts. EN8 7RP. England
Telephone: Lea Valley (01992) 710000

Pt. No. 100548
Issue 1